

TECHNICAL FOCUS ON THE PASTURE TOPPERS AND CHOPPERS

Technical guide for making the right purchase



JOSKIN®

PASTURE TOPPERS AND CHOPPERS

SPECIALISTS IN LEFTOVERS

Standard ✓ or optional + equipment on pasture toppers

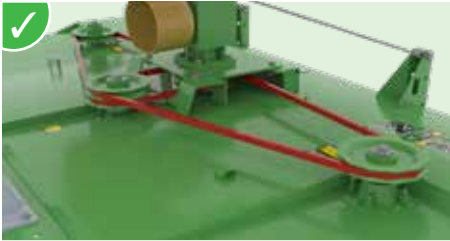

Belt drive to prevent mechanical damage to the machine.

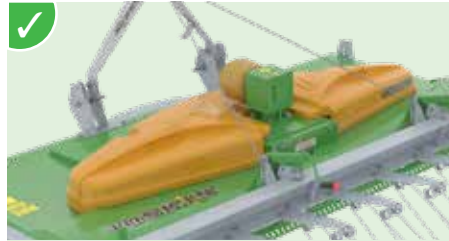

Protective cover for belts.



Blade holder with galvanised discs for excellent follow-up of the ground and optimal protection.

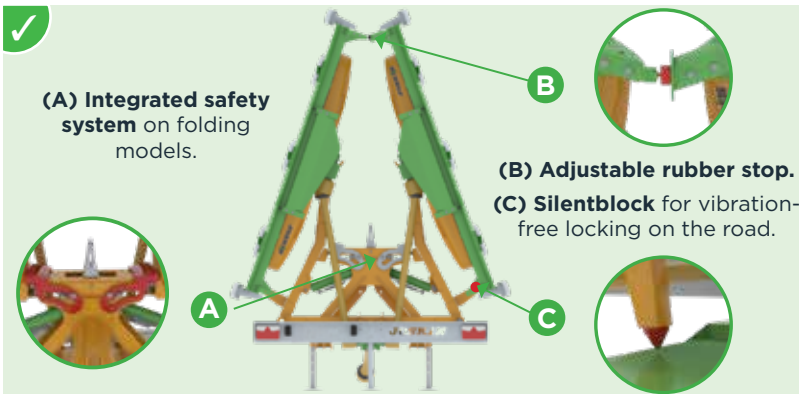

(A) Integrated safety system on folding models.

(B) Adjustable rubber stop.

(C) Silentblock for vibration-free locking on the road.



195mm self-retractable blades with twisted profile: better crankcase ventilation and more uniform distribution (on TR-ATR-TRT-BEV).

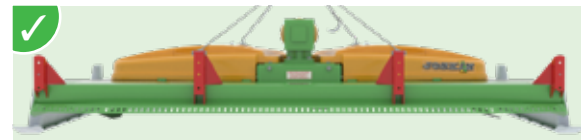

Pre-equipment for rear accessory.

Standard ✓ or optional + equipment on choppers



3-gearbox drive, with double flexible shock-absorbing security to protect the P.T.O.-shaft and the tractor.



BJ protective cover with vibration-free silentblock.

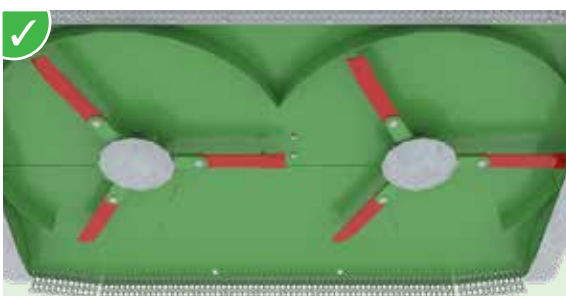

445 mm self-retracting blades with high inertia for quality chopping (BJ).



Blade holder with galvanised discs for excellent follow-up of the ground and optimal protection.





Pre-equipment for rear accessory.

COMMON OPTIONS

Standard ✓ or optional + equipment

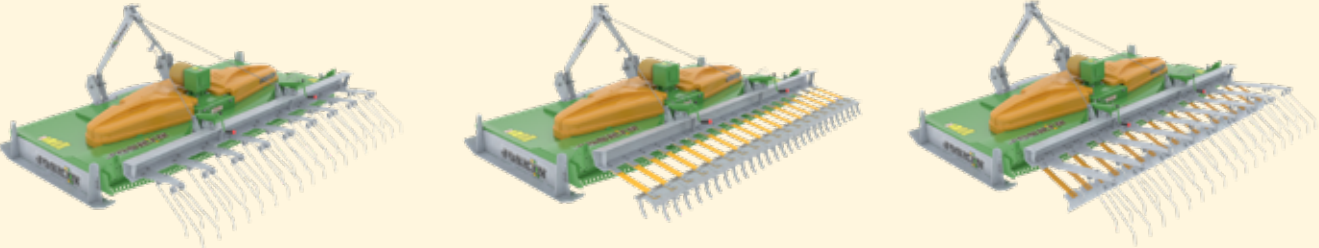
+





Rear galvanised aerator with 2 rows of spring tines (TR).



Rear aerator with curved tines on flexible leaves (TR).



One row of 15 cm scrapers and two rows of spring tines (TR).

✓

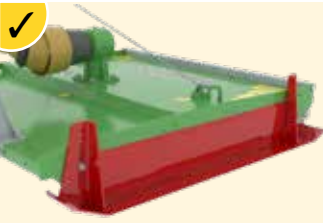

144 mm wide galvanised skids over the entire depth of the machines. Mowing height adjustable over 6 to 8 positions, depending on model.

+



Kit reflective boards (mandatory in some countries).

+

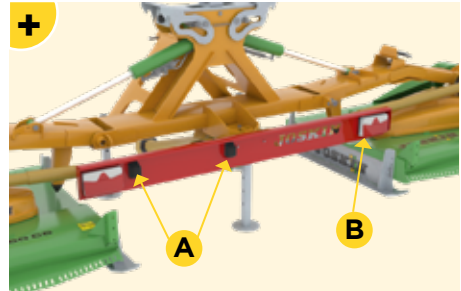

Lighting kit:
(A) Space for license plate with lights.
(B) Rear lights.

+



Front and rear protective chains.

+

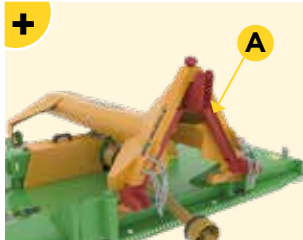

Traction arms for front-mounted machine (standard on ATR).
(A) Hitch triangle (option).

+

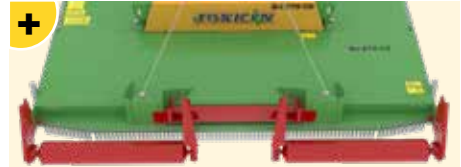

Rear rollers.

✓



540 rpm

TR/180/C2, TR/220/C3
TR/270/C3, TR/360/C4



1,000 rpm

TR/360/C4, ATR/270/C3
TR/270/DTH3, TRT/750/C6

P.T.O.-shaft

+



Swivel gauge wheels.

✓



Mandatory safety device. 

✓



6-spline Walterscheid P.T.O.-shaft.

+



P.T.O.-shaft with overrun clutch (standard on ATR and ABJ).

+



P.T.O.-shaft with shear bolt (standard on TRT, DTH3, BEV, BJ and ABJ).

WIDE RANGE OF PASTURE TOPPERS AND CHOPPERS

ROTARY PASTURE TOPPERS



TR/180/C2
Working width: 1.8 m
Transport width: 2.1 m
Number of rotors: 2
Weight: 350 kg



TR/220/C3
Working width: 2.2 m
Transport width: 2.5 m
Number of rotors: 3
Weight: 400 kg



TR/270/C3
ATR/270/C3
Working width: 2.7 m
Transport width: 3 m
Number of rotors: 3
Weight: 480 (TR) ou 570 (ATR) kg

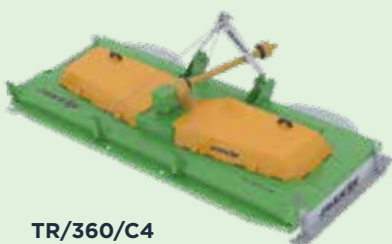

TR/360/C4
Working width: 3.6 m
Transport width: 3.9 m
Number of rotors: 4
Weight: 600 kg



TR/270/DTH3
Working width: 2.7 m
Transport width: 2.45 m
Number of rotors: 3
Weight: 550 kg



TRT/750/C6
Working width: 2 x 2,7 m
(7,5 m ATR)
Transport width: 2.5 or 3 m (ATR)
Number of rotors: 2 x 3
Weight: 1050 kg

GARDEN CHOPPERS

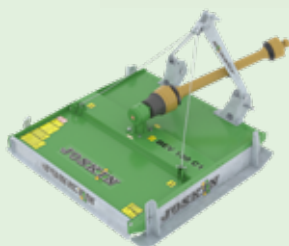

BEV/130/C1
Working width: 1.3 m
Transport width: 1.6 m
Number of rotors: 1
Weight: 180 kg

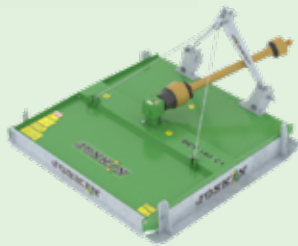

BEV/160/C1
Working width: 1.6 m
Transport width: 1.9 m
Number of rotors: 1
Weight: 280 kg

CHOPPERS

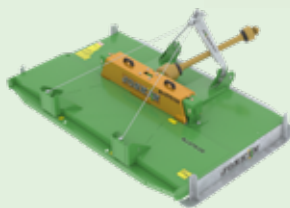

BJ/275/C2
ABJ/275/C2
Working width: 2.75 m
Transport width: 3 m
Number of rotors: 2
Weight: 680 (BJ) ou 770 (ABJ) kg

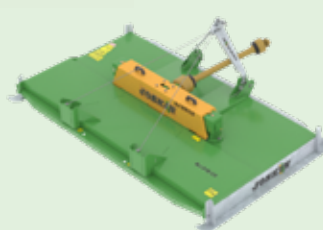

BJ/315/C2
Working width: 3.15 m
Transport width: 3.4 m
Number of rotors: 2
Weight: 760 kg

JOSKIN®



www.joskin.com • Rue de Wergifosse, 39 - 4630 Soumagne (Belgium)

E-mail: info@joskin.com • Tel.: +32 (0)4 377 35 45