

TECHNICAL FOCUS ON **SIROKO**

Technical guide for making the right purchase



JOSKIN

SIROKO

LOWERED, NARROW BODY!

Equipment: standard ✓, option + or at a reduced price -

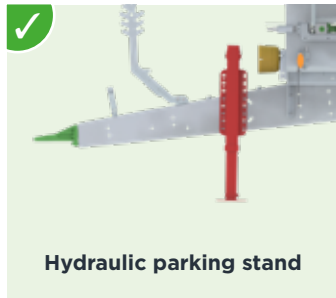

Hydraulic parking stand



Skid for hitch hook

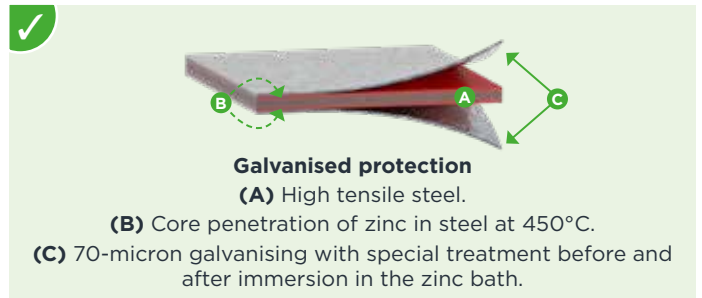

Control of parking stand by **double-acting hand pump (DA)**.

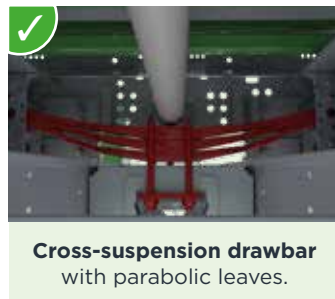

Cross-suspension drawbar with parabolic leaves.

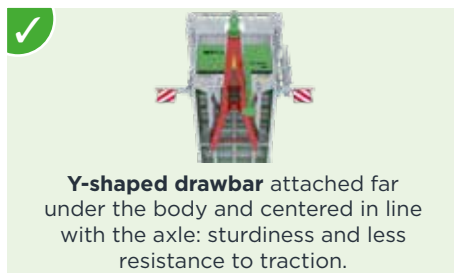
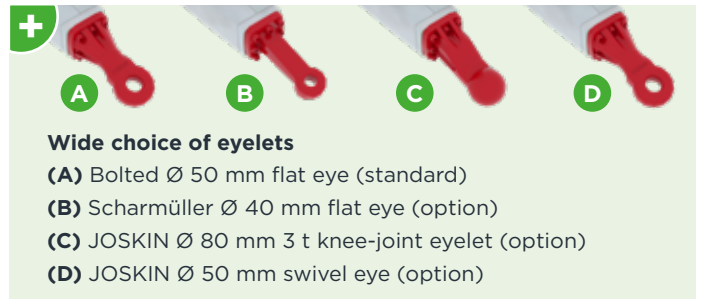

Y-shaped drawbar attached far under the body and centered in line with the axle: sturdiness and less resistance to traction.

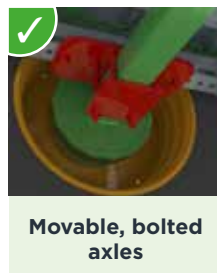

Movable, bolted axles

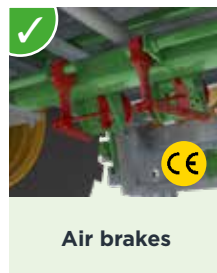

Air brakes

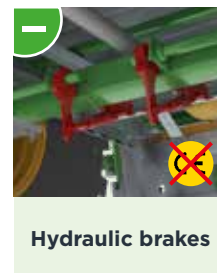

Hydraulic brakes

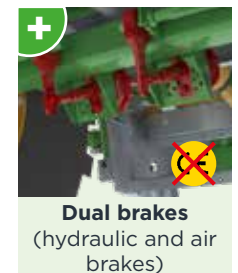

Dual brakes (hydraulic and air brakes)



Front case protected by a cover with two compensating cylinders.



Hydraulic installation and Ferti/Easy-CONTROL electronic control protected in the front case.



Sturdy galvanised steel mudguards.



Wheel chocks (1 pair)



Folding ladder to view the inside of the body.

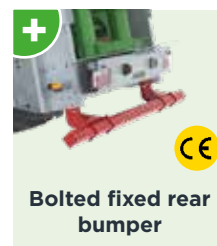

Bolted fixed rear bumper

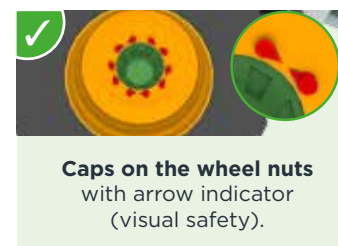

Caps on the wheel nuts with arrow indicator (visual safety).

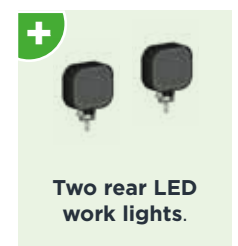

Two rear LED work lights.

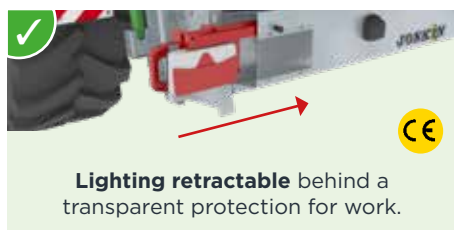

Lighting retractable behind a transparent protection for work.

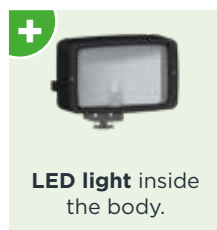

LED light inside the body.



LED flash bar

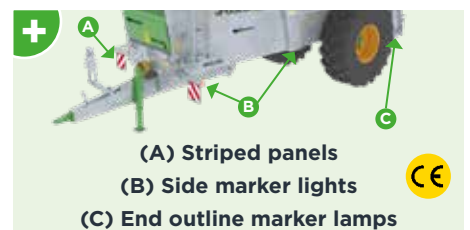

(A) Striped panels
(B) Side marker lights
(C) End outline marker lamps



✓
Flow regulator with compensated pressure



Ferti-CONTROL 300

Electrical moving floor control.



Ferti-CONTROL 500

Moving floor control with electrical reverser.



Easy-CONTROL

Moving floor control with electrical reverser and extra functions.

Simplified DPA



Ferti-CONTROL 400

Full control of the electrohydraulic functions of the vehicle.

Precision DPA

**DPA: proportional flow control.*

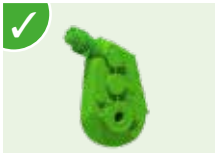

✓
Compact **reduction gearbox** for moving floor drive.

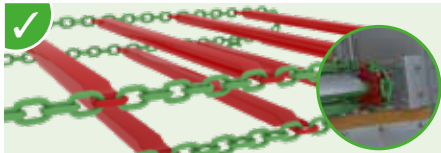

✓
Closed tubular slats welded to Ø 14 mm shipping chains (to avoid material storage) + moulded gearwheels.

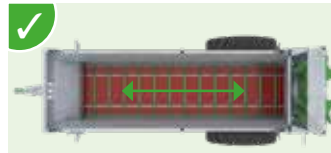

✓
Moving floor direction reverser via hydraulic control valve (DA) and pressure-compensated flow regulator.



✓
Digital hour counter



✓
Narrow body made of 4 mm sheet metal (S420MC) with reinforcement folds over the entire length.

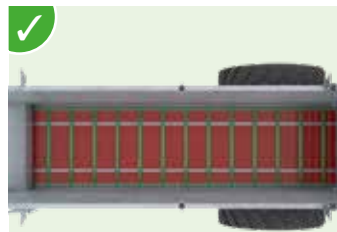

✓
Bolted galvanised **floor** for easy replacement in case of wear.

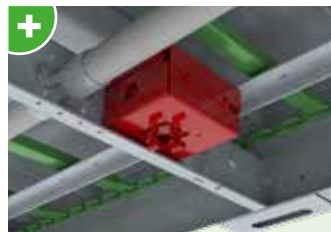

✓
Audible door-opening indicator (CE safety).



✓
Reversing camera with screen, for safety when starting the beaters.



✓
2 Ø 820 mm (S4008) or 900 mm vertical beaters, 423 rpm, with 10 mm thick spiral welded to tubes with a diameter of 140 mm (S4008) or 190 mm for other models.

(A) Upper beater lubrication within reach.
(B) Galvanised cord cutter.



✓
Reversible, twisted **HARDOX 450 beater knives** for good spreading.



✓
Mechanical chain tensioners with tension springs and visual adjustment indicator.



✓
Galvanised rear central partition (incompatible with SIROKO S4008/8V)



✓
Very sturdy galvanised ribbed **guillotine door**, with additional reinforcement at the basis.



✓
Retractable blades



✓
HARDOX 450 protection plate for the spreading table.



✓
Beater protective grating (mandatory for road traffic in some countries).



✓
Large hydraulic limitation board (right, left or both sides).



✓
Front extension with sight window integrated to the body.



✓
Extension for headboard (to be bolted, 45 cm).



✓
Aluminium or wooden **250 mm extensions**.



✓
PVC protection to protect the upper body edge.

WIDE RANGE OF SIROKO

VERTICAL MUCK SPREADERS

Lowered JOSKIN Muck Spreader for Quality Spreading

SIROKO

- ✓ Range from 4.15 to 5.5 m long in front of the door
- ✓ Volume (without extensions) from 7.7 to 12.98 m³
- ✓ Tractor power up to 130 hp

The dimensions below are given in metres (m) without extensions.

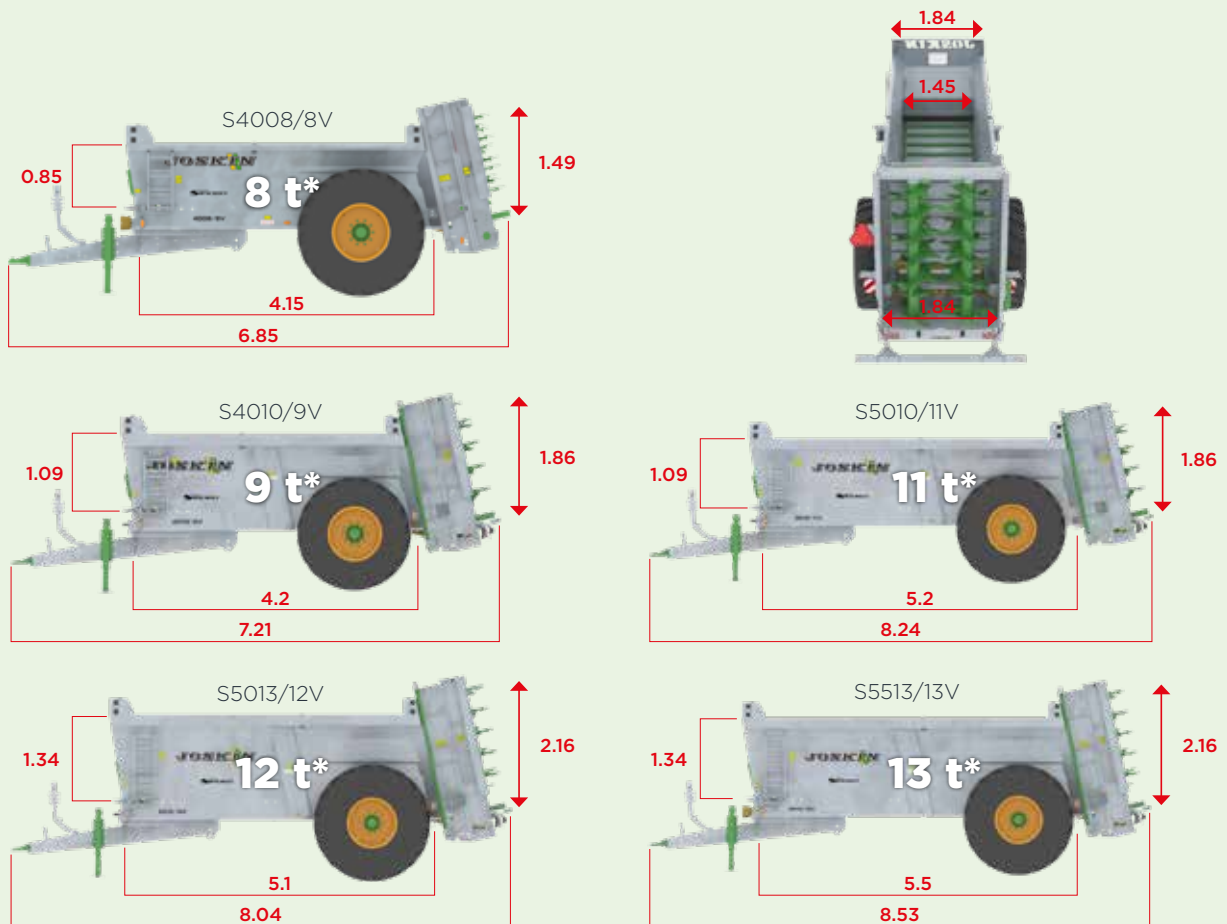

*Technical payload - Always comply with the maximum weight allowed on the road.

Understanding Model Names

- The first 2 digits indicate the average length of the body to the door (rounded in dm).
 - The next 2 give the average height (rounded in dm).
- The last 2 indicate the body volume without extensions up to the door (in m³).
 - The letters indicate the number of axles: V = single axle.

Example: model S4008/8V corresponds to a muck spreader with a body length of 4.15 m in front of the door, a height of 0.85 m, a single axle and a volume of around 8 m³ without extensions.

JOSKIN



www.joskin.com • Rue de Wergifosse, 39 - 4630 Soumagne (Belgium)

E-mail: info@joskin.com • Tel.: +32 (0)4 377 35 45