

TECHNICAL FOCUS ON PENDITWIST AND PENDISLIDE BASIC SPREADING BOOMS

Technical Guide for BASIC Spreading Booms



Penditwist BASIC 6 m



Pendislide BASIC 7.5 m

JOSKIN®

BASIC SPREADING BOOMS

SMALL-WIDTH LINE SPREADING BOOMS (6 and 7.5 m) WITH OR WITHOUT SKIDS

Standard ✓ or optional + equipment

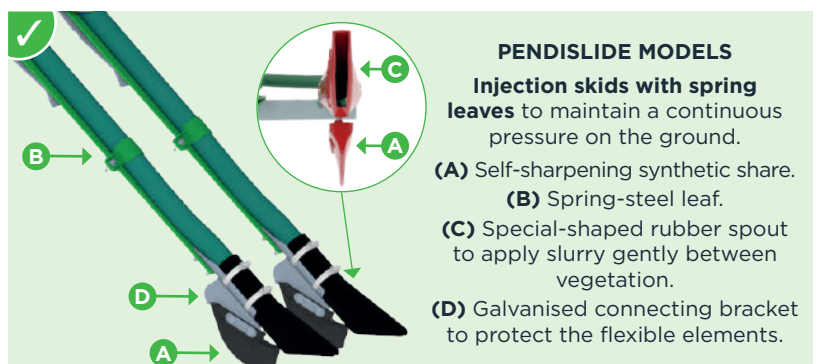
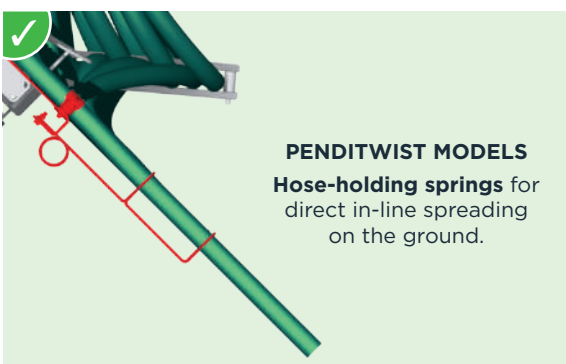
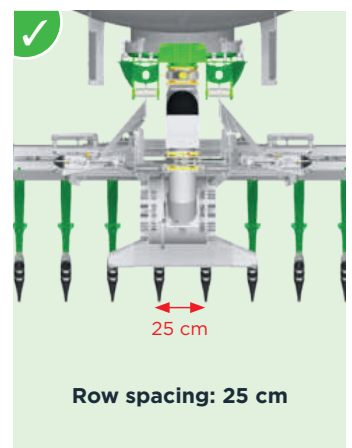
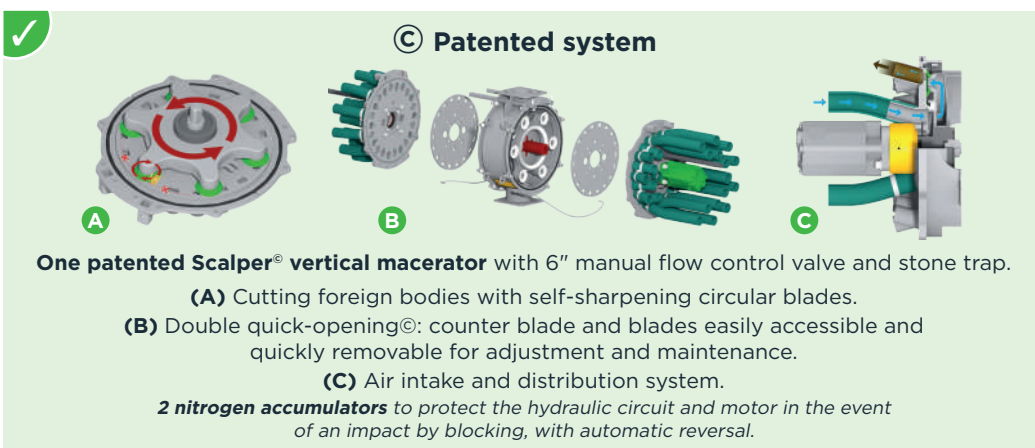
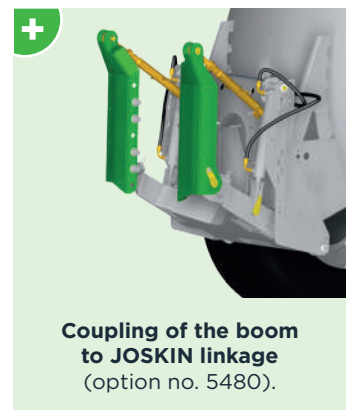
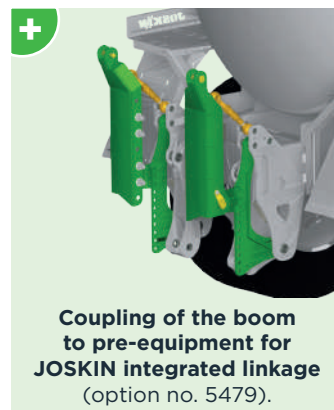
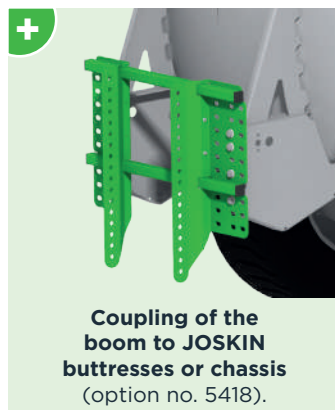
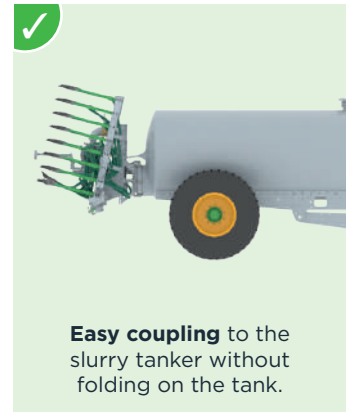
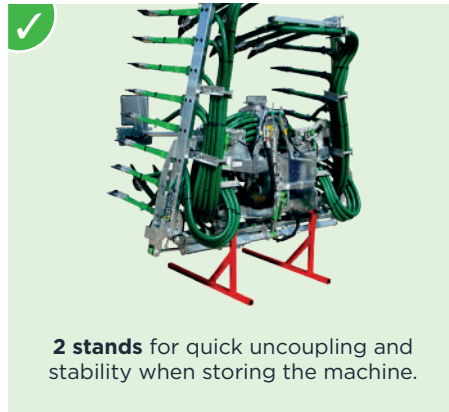
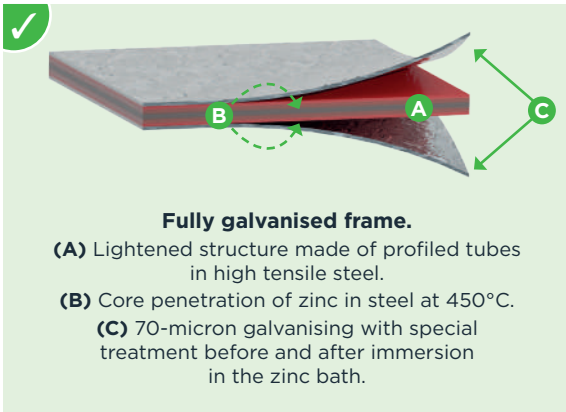

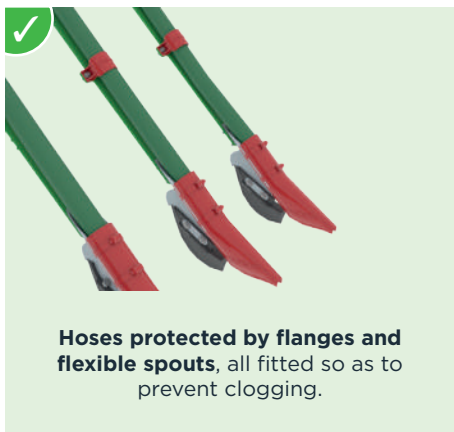

Hoses protected by flanges and flexible spouts, all fitted so as to prevent clogging.

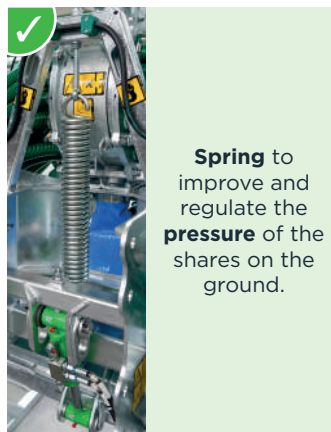

Spring to improve and regulate the pressure of the shares on the ground.

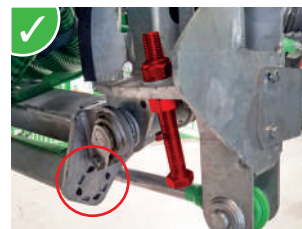

Adjustable stop to ensure even pressure of all elements on the ground.

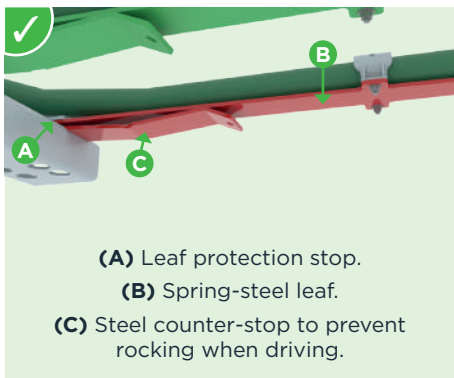

(A) Leaf protection stop.
(B) Spring-steel leaf.
(C) Steel counter-stop to prevent rocking when driving.



Hydraulic, semi-automatic control protected inside the housing

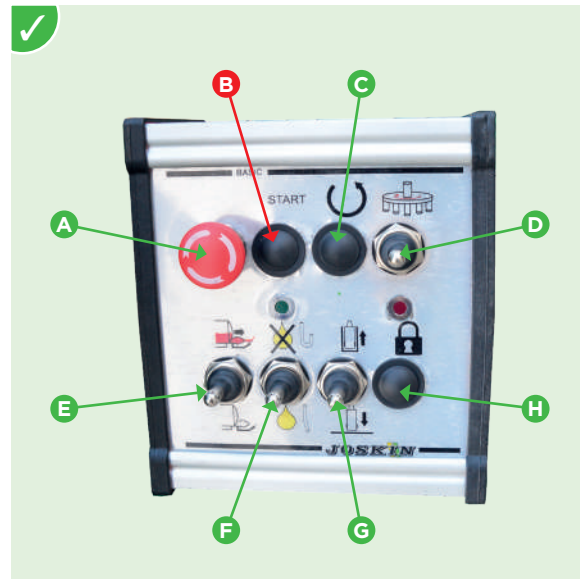

Full electrohydraulic control of the machine with automaton.

(A) Emergency stop.

(B) Automatic sequence at the beginning/end of the row*.

(C) Reverse the direction of rotation of the macerator.

(D) Macerator control: neutral/clockwise/anti-clockwise rotation

(E) Open/Close the rear valve.

(F) Lower/Lift hoses (TWIST anti-drip system).

(G) Fold/Unfold the spreading boom.

(H) Lock-Matic road security: mechanical locking of the folded boom.

Manual Mode

*At the beginning of the row, the automatic sequential control activates the following functions successively: (F) lower the hoses, (E) open the valve, (D) activate the macerator and (C) reverse the direction of rotation of the macerator to clean the blades and ensure uniform wear of the counter blade. At the end of the row, it closes the rear valve (E), deactivates the macerator (D) and lifts the hoses (TWIST anti-drip system (F)).

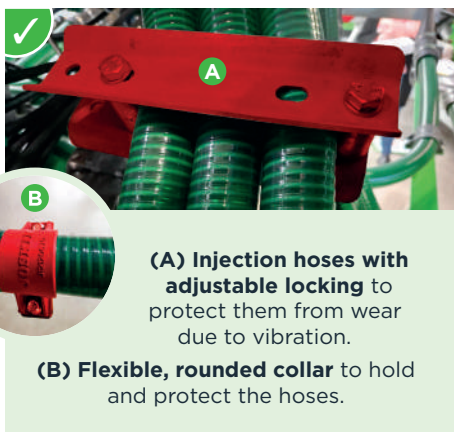

(A) Injection hoses with adjustable locking to protect them from wear due to vibration.

(B) Flexible, rounded collar to hold and protect the hoses.

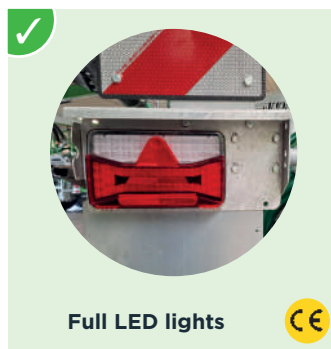

Full LED lights

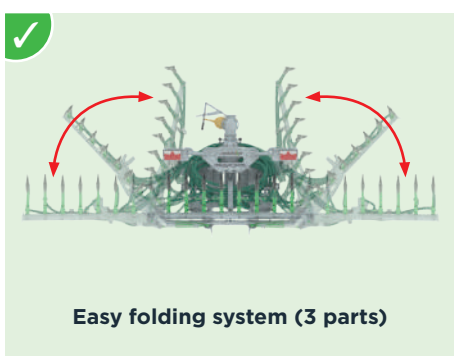

Easy folding system (3 parts)

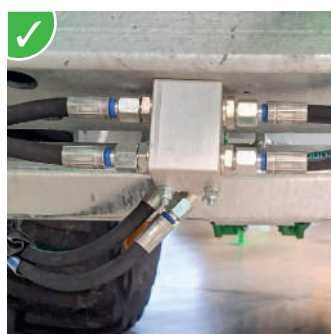

Hydraulic distribution block for folding cylinders

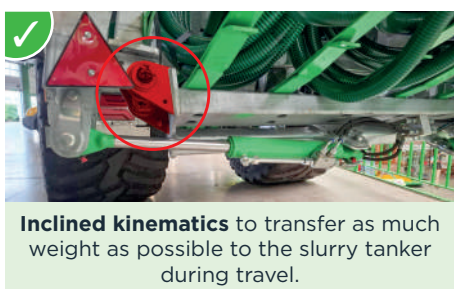

Inclined kinematics to transfer as much weight as possible to the slurry tanker during travel.



Macerator feeding valve (Ø 150 mm) with extra outlet for optional exact scatterer.

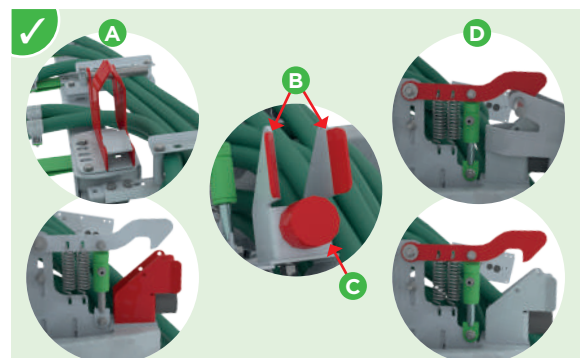

Lock-Matic security to automatically lock the boom during road transport + guide cone.

(A) Male cone for locking the extensions on the road.

(B) Extension reception cone.

(C) Silentblock to prevent vibration.

(D) Mobile safety hook.

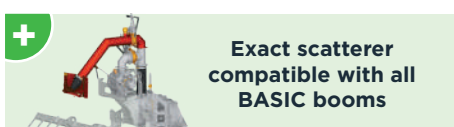

Exact scatterer compatible with all BASIC booms

4 Boom Models of 6 and 7.5 m

PENDITWIST AND PENDINGSLIDE BASIC

Line Spreading Booms: Peditwist

Theoretical NH₃ losses (ammonia): 25 to 45%*

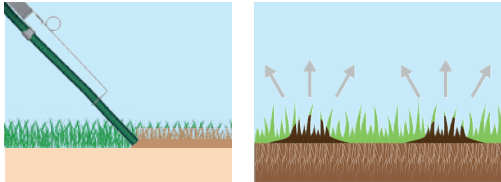

Line Spreading Booms with Skids: Pendingslide

Theoretical NH₃ losses (ammonia): 15 to 40%*

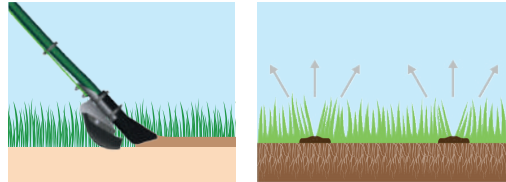

*Source: Brusselman E., Beck B., De Campeneere S., Demeyer P., Goossens K., Kerselaers E., Maertens L., Millet S., Reubens B., Riebbels G., Vandaele L., Vangeyte J., Zwertvaegher I., "Screening van maatregelen die kunnen leiden tot de reductie van ammoniakemissie afkomstig van landbouw", [ilvo.vlaanderen.be](https://ilvo.vlaanderen.be/uploads/documents/ILVO_PAS_Literatuurstudie_finaal.pdf), 2016, https://ilvo.vlaanderen.be/uploads/documents/ILVO_PAS_Literatuurstudie_finaal.pdf (consulted on 11.12.2023).

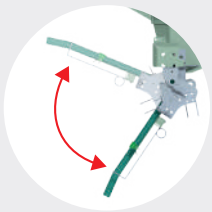

TWIST anti-drip lifting system
to prevent slurry losses on the road and
in the field when manoeuvring.

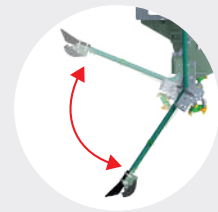

Peditwist BASIC 60/24RP1
24 outlets - 1 macerator

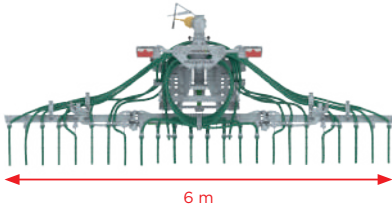

3-part folding system

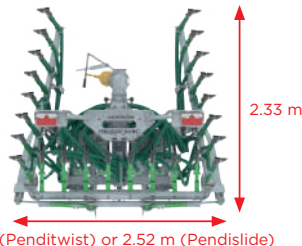

Pendingslide BASIC 60/24PS1
24 outlets - 1 macerator

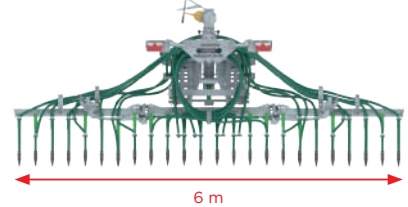

Peditwist BASIC 75/30RP1
30 outlets - 1 macerator

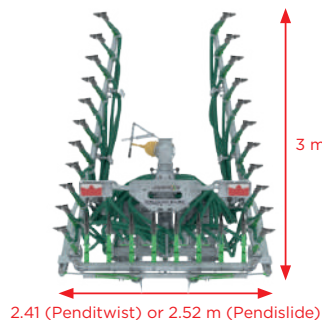
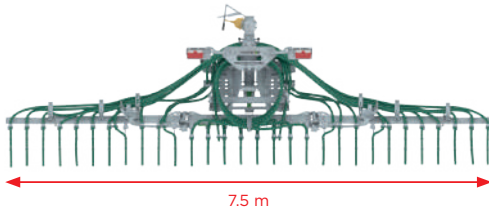

Pendingslide BASIC 75/30PS1
30 outlets - 1 macerator

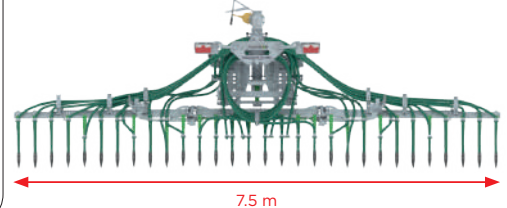

**JOSKIN, the spreading specialist with over 65 IMPLEMENT MODELS
and a unique experience in slurry spreading FOR OVER 40 YEARS!**

JOSKIN



www.joskin.com • Rue de Wergifosse, 39 - 4630 Soumagne (Belgium)

E-mail: info@joskin.com • Tel.: +32 (0)4 377 35 45